







13 801 845



- Ausladung 210 mm
- runder Normalstrahl
- Bohrungsdurchmesser 37 mm
- Anschluss 1/2"
- Steckanschluss-Montage
- Durchfluss max. 21,5 l/min bei 3 bar Fließdruck

	Platin gebürstet	13 801 845-06
	Chrom	13 801 845-00
	Dark Chrome	13 801 845-19
	Schwarz matt	13 801 845-33
	Chrom gebürstet	13 801 845-93
	Dark Platinum gebürstet	13 801 845-99

Empfohlenes Zubehör



- UP-Wandwinkel -** 35 085 970 90
- Max. Einbautiefe 163 mm
 - Min. Einbautiefe 90 mm

13 801 845

mm [inches]

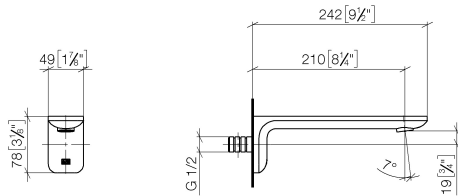

Durchflussdiagramm

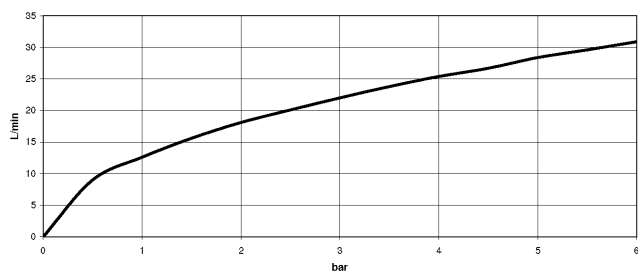

Zertifikate

IAPMO_4976 (6). LGA_29012. WRAS_2207003.

13 801 845

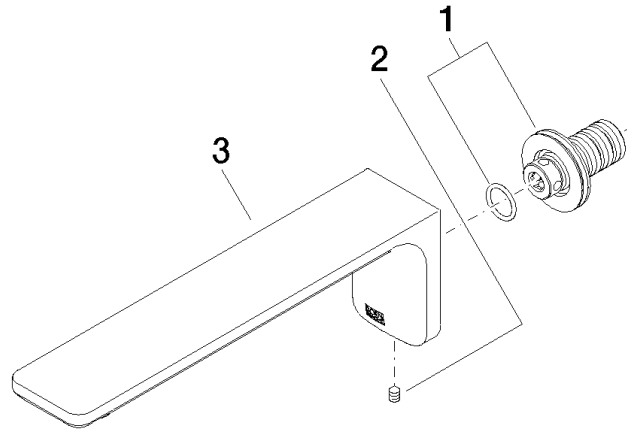

Ersatzteilstückliste

Nr.	Artikelnummer	Benennung	Verbaumenge	Lieferzeit
1	90 24 03 108 00 90	Nippel Set	1	2
2	90 31 11 004 00 90	Stift	1	2
3	90 11 84 014 02-06	Auslauf	1	10